

# klénz

## OWNER'S MANUAL

**MODEL: KHS-100 (F)**



Thank you for purchasing KLENZ Product.  
Read this Owner's Manual before operating KLENZ Product  
and keep it handy for reference at all times.

[www.klenz.kr](http://www.klenz.kr)

# TABLE OF CONTENTS

	Page
<b>SPECIFICATION</b> .....	P3
PARTS NAME .....	P4,P5
<b>■ INSTALLATION</b>	
SINGLE UNIT .....	P6
<b>■ OPERATION</b>	
TIME MODE / HOW TO SETUP .....	P7
MICRO SWITCH .....	P8
CONTROL PANEL .....	P9
<b>■ DEACTIVATION</b>	
MICRO SWITCH, CONTROL PANEL .....	P10
<b>USAGE / APPLICABLE OBJECT</b> .....	P11
SAFETY INSTRUCTION .....	P12,P13
FILTER CLEANING .....	P14

# SPECIFICATION

Sterilizing Method: Ozone

Product Name	Helmet Care Solution
Model	KHS-100 (F)
Rated Input	DC 12V 5A
Product Dimension (mm)	(W)260 x (D)300 x (H)108
Weight (kg)	1 kg
Manufacturer	Klenz Co., Ltd
Origin	South Korea

※ Accessories: Adapter, Owner's Manual, Bolts

※ Design and Specifications are subject to change without notice.

# PARTS NAME

## MAIN UNIT

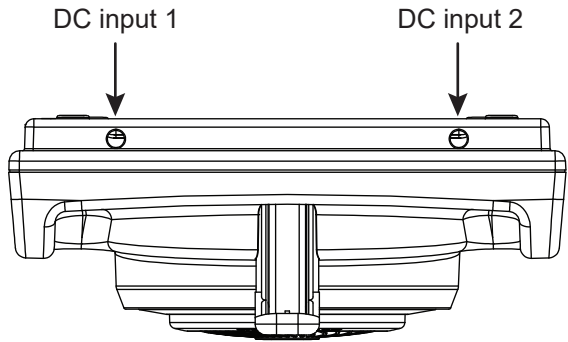

## FRONT

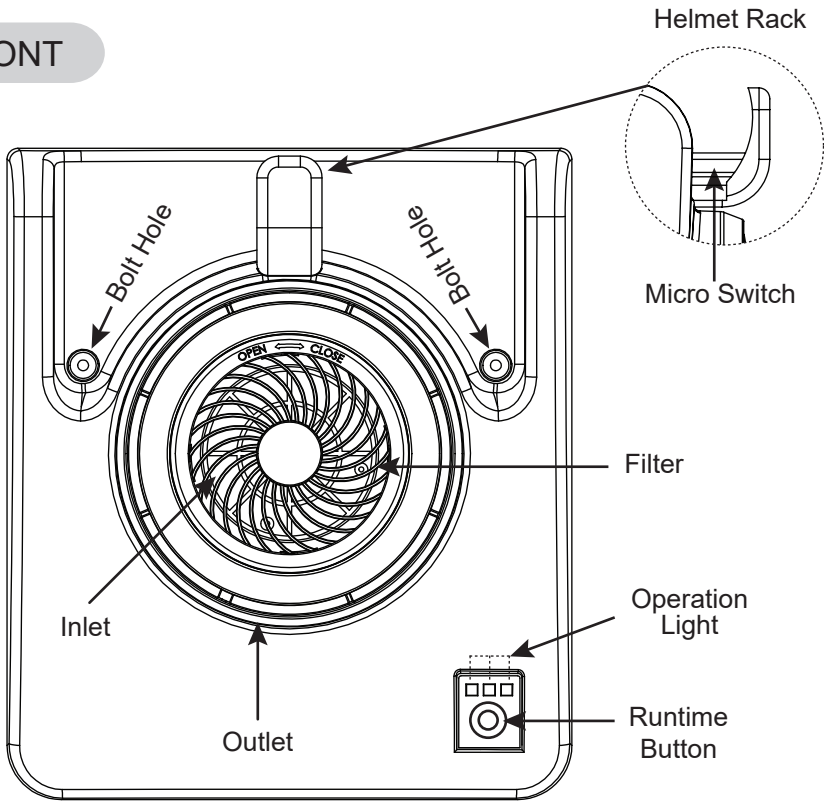

# PARTS NAME

## Adapter

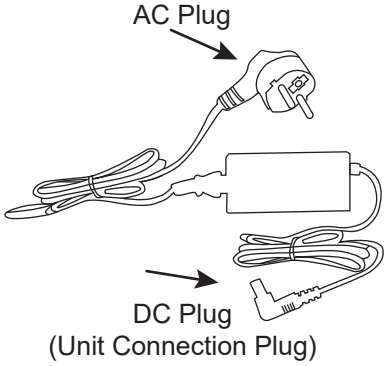

## Fixing Bolt

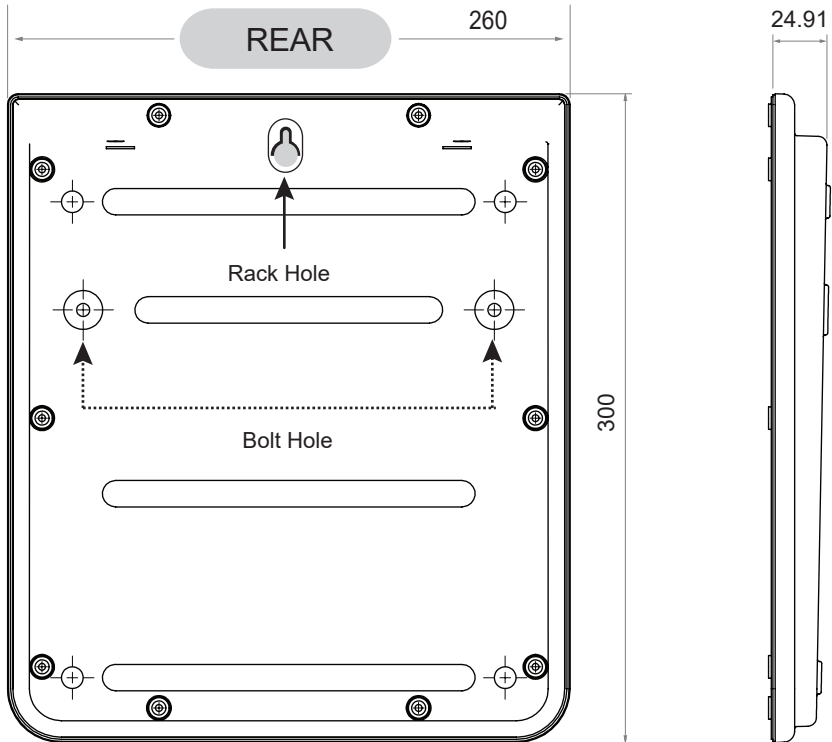
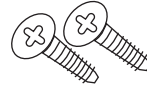

# INSTALLATION - SINGLE UNIT

1. Place the Main Unit on a flat surface or mount it as shown below.



[ on the desk ]



[ on the side of the desk ]

2. Insert DC plug into DC input (1,2) in the Main Unit and insert AC Plug into the outlet.

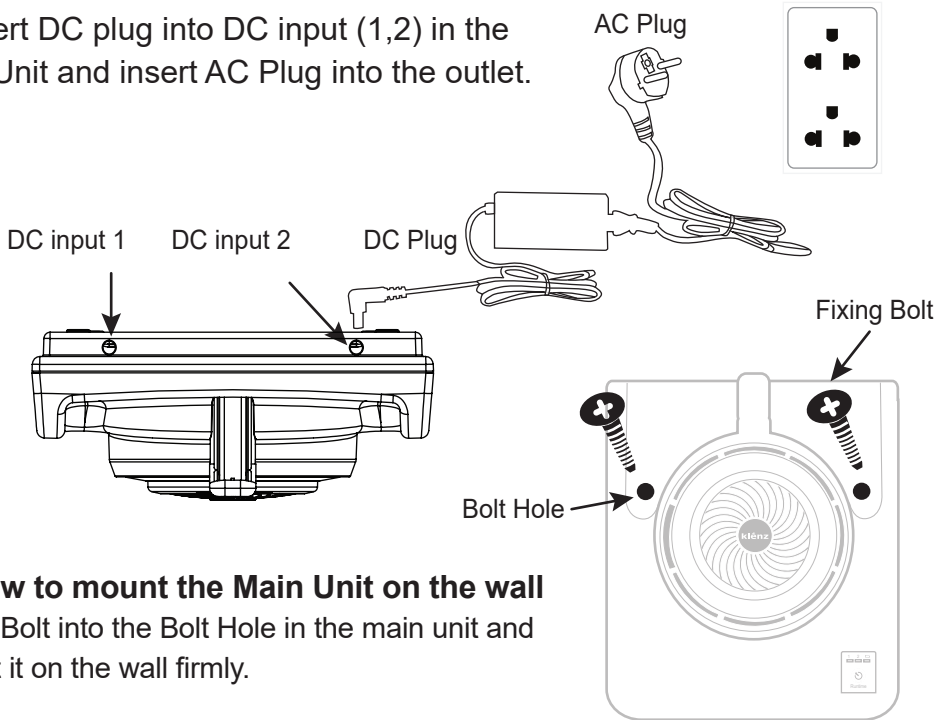

※ **How to mount the Main Unit on the wall**  
Insert Bolt into the Bolt Hole in the main unit and mount it on the wall firmly.

# TIME MODE / HOW TO SETUP

## TIME MODE

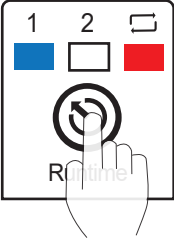
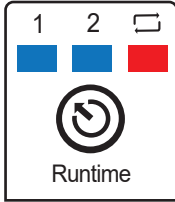
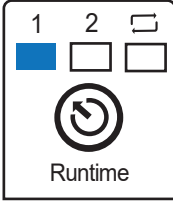
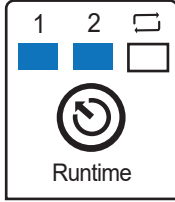
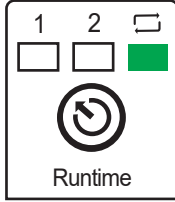
MODE 1	MODE 2	MODE 3	MODE 4	FINISH
				
<p><b>Press 1 Time</b></p> <ul style="list-style-type: none"> <li>- Operating Time <b>60</b> Minutes.</li> <li>- Heater <b>ON</b></li> </ul>	<p><b>Press 2 Times</b></p> <ul style="list-style-type: none"> <li>- Operating Time <b>90</b> Minutes.</li> <li>- Heater <b>ON</b></li> </ul>	<p><b>Press 3 Times</b></p> <ul style="list-style-type: none"> <li>- Operating Time <b>60</b> Minutes.</li> <li>- Heater <b>OFF</b></li> </ul>	<p><b>Press 4 Times</b></p> <ul style="list-style-type: none"> <li>- Operating Time <b>90</b> Minutes.</li> <li>- Heater <b>OFF</b></li> </ul>	<p><b>Complete</b></p> <ul style="list-style-type: none"> <li>- Press Runtime button to operate again.</li> </ul>

## HOW TO SETUP TIME MODE on the Controller

- When (Runtime button) is pressed, the operation lamp will light up in the final used mode of use. (Rf.) Factory Release: Mode 1)
- Press (Runtime button) to change the mode sequentially.  
(Example: Mode 1 → Mode 2 → Mode 3 → Mode 4 → Mode 1)
- After changing to the preferred mode, the operation lamp blinks after about 3 seconds. While the operation lamp blinks, If (Runtime button) is pressed, the machine stops working.  
(Lamp blinks means MODE is set up)
- If you need to change the MODE when the operation lamp is blinking, Power the product on again.  
(The MODE cannot be changed while the lamp is blinking.)
- MODE change is available before the lamp blinks.

# OPERATION\_ MICRO SWITCH

## How to operate wall mounted KHS-100 (F)

After plugging in the power, the Product may be operated either by Micro Switch or Runtime Button.

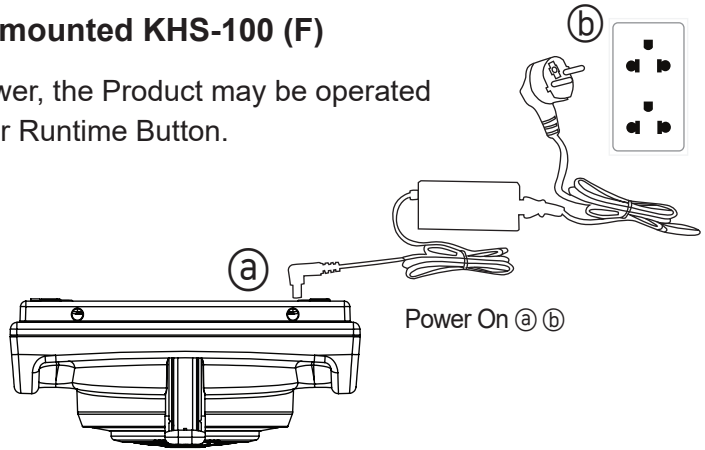

## 1. MICRO SWITCH

When mounted by upright position, hang the helmet on the Micro Switch and the Product will automatically operate for preset time (60 minutes)

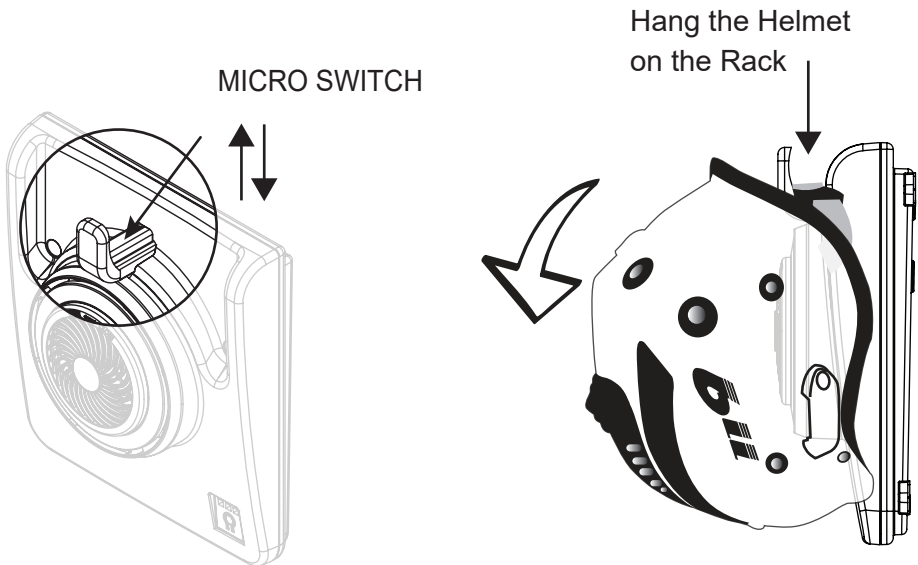



# OPERATION\_ CONTROL PANEL

## How to operate KHS-100 (F) on flat surface.

Operated by pressing the Runtime button.  
On flat surface, Micro switch is deactivated.

### 2. CONTROL PANEL (Runtime button)

#### CONTROL PANEL

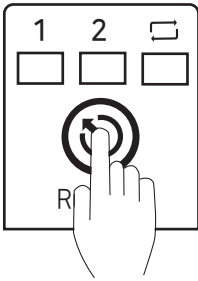

After the Main Unit is powered,  
press the Runtime button  
as per preferred mode.

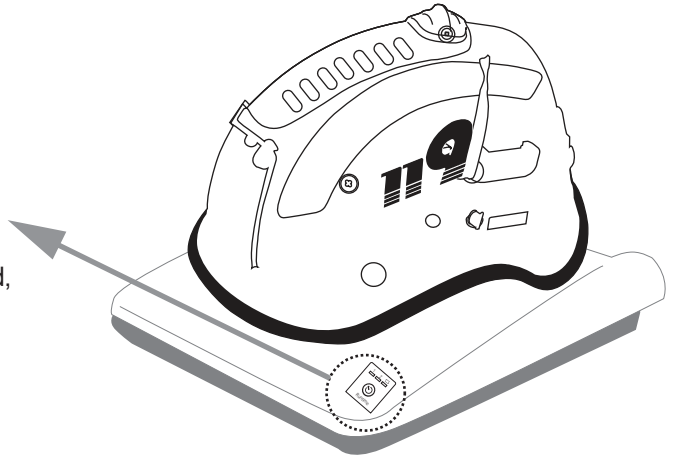

# DEACTIVATION

## How to inactive

### 1. MICRO SWITCH

Lift the helmet from the rack and the Product will automatically deactivate.

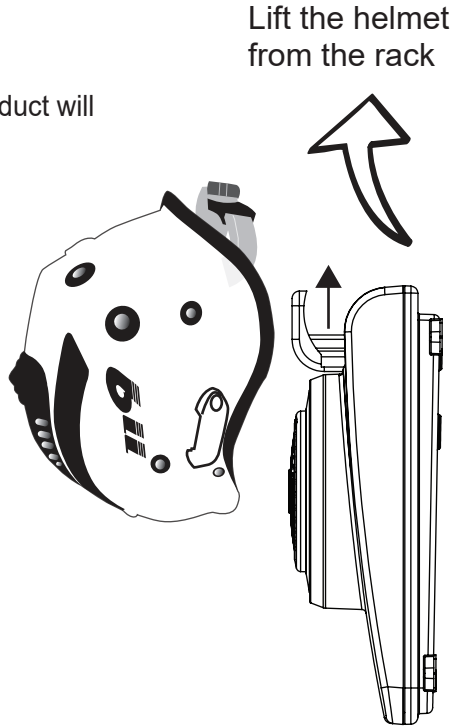
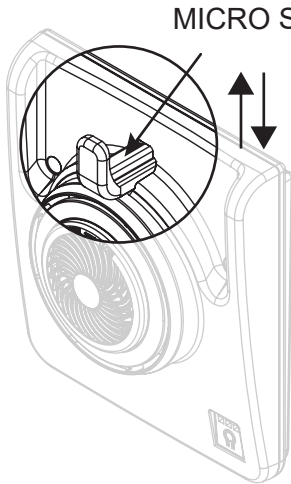

### 2. CONTROL PANEL

When the mode light flashes, press Runtime button to deactivate.

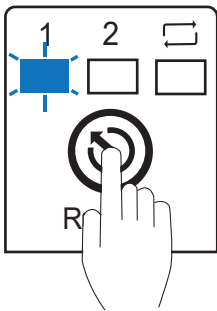

Press **Runtime** button

Operation Light  
Goes Out

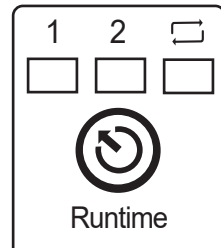

STOP

# USAGE

Please put helmet on the main unit or hang it on the rack of main unit for sterilizing.

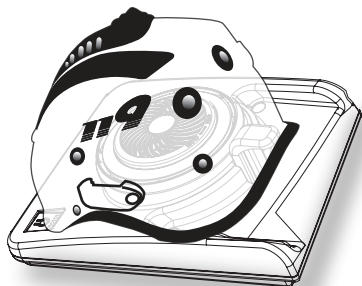

On the flat surface

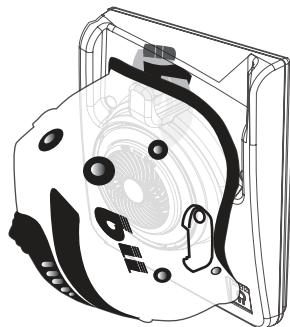

On the wall

# APPLICABLE OBJECTS

**Helmet for Motorcycle, Safety, Bicycle, and cap, etc.**

※ Reference ※

Lightweight objects, such as cap, may not be operated by Micro Switch. Lightweight objects must be operated by Runtime button.

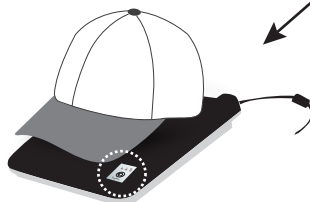
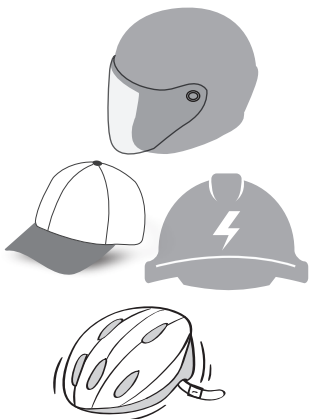



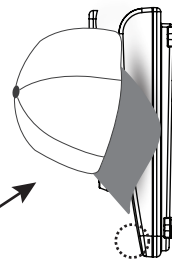

Lightweight





Press Runtime button for operation



## SAFETY INSTRUCTION

 <b>Warning</b>	This mark represents, “Expecting death or serious injury”
 <b>Caution</b>	This mark represents, “Expecting the loss of life and property”
 <b>Prohibition</b>	This mark represents “Prohibition”
 <b>Compulsion</b>	This mark represents “Compulsion” you must comply”
 <b>Connection</b>	This mark represents “Precaution of an electric shock”

## **WARNING & CAUTION**

-  Please don't inhale outlet during operation of the Product.  
It generates small amount of O<sub>3</sub> during the operation.  
(It may cause vomit, headache or dizziness)
-  Do not dismantle, repair or modify the Product.  
It may cause damage or electric shock.
-  Do not put anything that could break, such as vase, bottle, or wet item on the Product. It may cause danger of fire or electric shock.
-  Please stop using in case water is spilled into the Product.  
It may cause an electric shock and/or malfunction.

## SAFETY INSTRUCTION



**Do not put wet objects on the Product.**

It may cause electric shock and malfunction.



**Do not twist or unplug the Power Cord too strong.**

It may cause electric shock and malfunction and fire.



**Do not touch the adapter code with wet hand.**

It may cause electric shock and malfunction and fire.



**Only use the connection socket and plug pointed.**

It may cause electric shock and malfunction and fire.



**Please avoid impact on Product or dropping while moving.**

It may cause malfunction and injury.



**Do not give physical force which can effect the Product.**

It may cause malfunction and injury.



**Do not spray water directly to the Product when you cleaning it.**

It may cause electric shock and malfunction.



**When cleaning the device, please be careful of using detergents.**

it may cause discoloration, peeling.



**Please don't use detergents containing benzene, alcohol or solvents.**

It may cause discoloration, peeling or fire.

## BEFORE USE

This is a very delicate Product, please read the following instructions prior to using the Product.

- ▶ It is not water proof. Refrain from operating the Product if wet.
- ▶ Do not put heavy objects on the Product.
- ▶ Do not step on the Product.
- ▶ When cleansing the Product, use soft cloth.
- ▶ Do not use thinner or benzene when cleaning the Product.
- ▶ Only use provided Power Supply.
- ▶ Keep out of reach of children.

# FILTER CLEANING

## 1. Removing Filter

Twist the filter to “OPEN” direction, then remove the filter.

※ It is recommended to carry out the filter cleaning once a week.

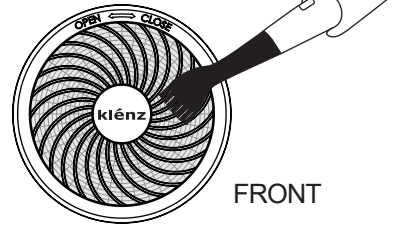

## 2. Cleaning Filter

Gently remove the dust attached to the filter with a vacuum cleaner.

## 3. Installing Filter

Insert A to B (as shown in the diagram), twist the filter to “CLOSE” direction.

(“KLENZ” logo should be right side up when installed properly)

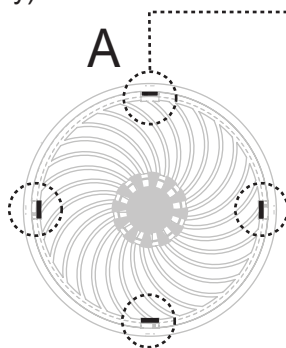

REAR

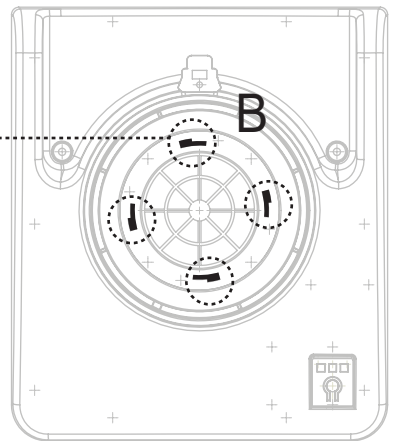

MAIN





"Shape can be imitated, but technology and credibility cannot be imitated."

**Klenz Co.,Ltd.**  
[www.klenz.co.kr](http://www.klenz.co.kr)

For detailed information about the product, please refer to the website.

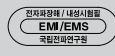

### Main Number

Tel : +82-32-668-0780~2

### Customer Service Center

Product Consultation and Inquiries.

Reporting Usage Inconveniences and Malfunctions.

Tel : +82-1588-8966